

零件圖  
PARTS LIST

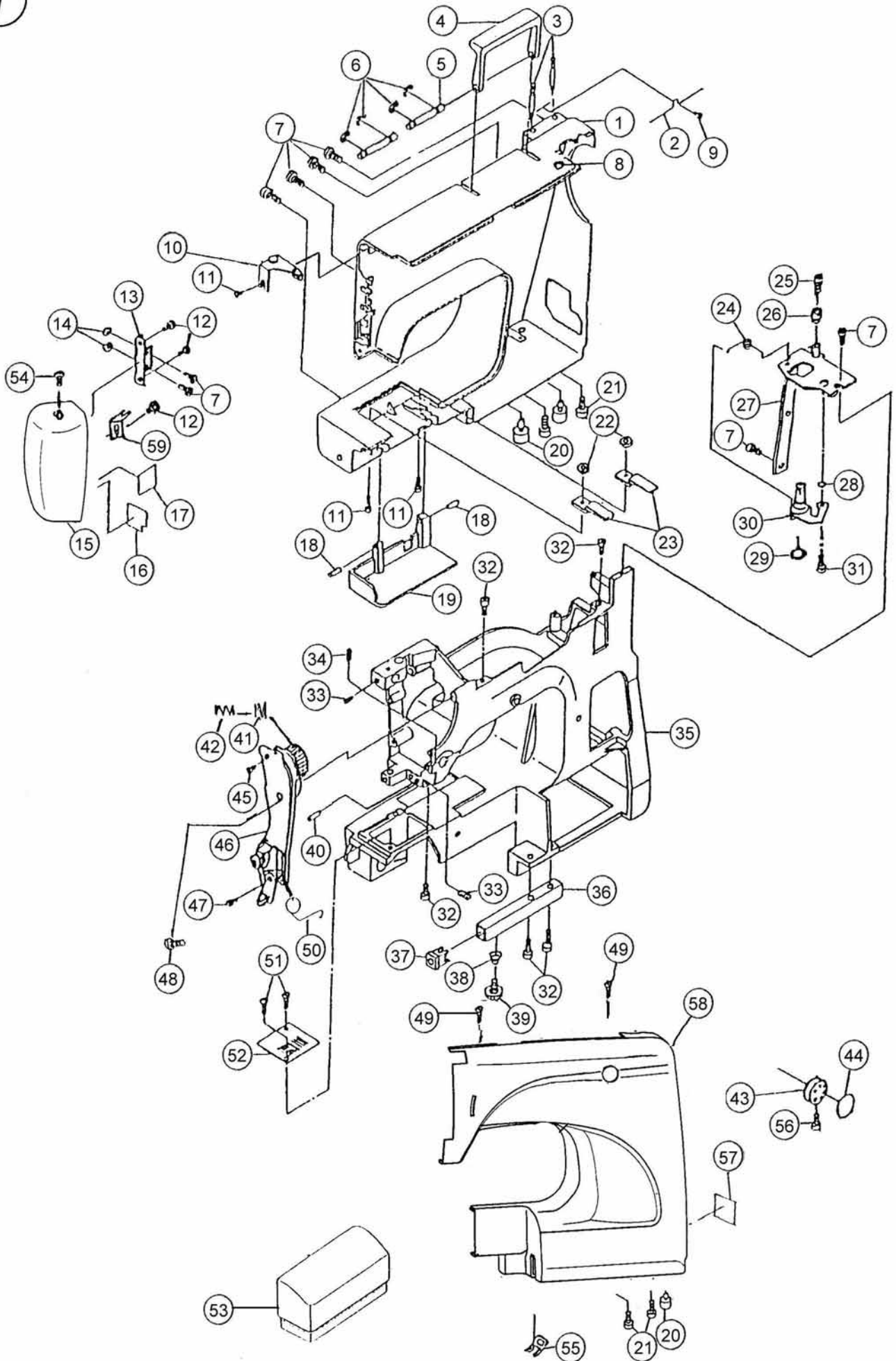

1



ref no.	part no.	name of parts
---	-----	-----
01	271103000	REAR COVER
02	270007000	SPOOL PIN SPRING
03	301027005	SPOOL PIN A1
04	353004122	HANDLE
05	270174009	HANDLE PIN
06	000000103	SNAP RING 3D
07	301008000	SET SCREW
08	250125014	ADJUSTING HOLE PLUG (W)
09	000011923	SET SCREW
10	230502006	THREAD GUIDE COMP
11	301016001	SET SCREW
12	000011912	SET SCREW
13	380502004	FACE PLATE HINGE
14	301193003	NUT
15	270306002	FACE PLATE (DRAWING→ 270306507)
16	270092105	HEAT-SHIELD PLATE
17	250083101	HEAT-SHIELD PLATE
18	000003405	SPRING PIN 3*18
19	250031023	SHUTTLE RACE COVER (W)
20	250020007	RUBBER
21	356017002	SET SCREW
22	301151009	NUT
23	250032002	SHUTTLE RACE COVER SPRING PLATE
24	250045008	BOBBIN WINDER SPRING C
25	353128008	SET SCREW
26	380067002	BOBBIN WINDER STOPPER
27	250016000	BOBBIN WINDER SUPPORTING PLATE
28	370069003	WASHER 5.1*18 t=0.5
29	353030002	RUBBER RING
30	360501001	BOBBIN WINDER COMP
31	353125005	HINGED SCREW
32	250087002	SET SCREW
33	301046000	SET SCREW
34	301087003	SET SCREW
35	250507003	ARM/BED
36	250022021	AID LEG (W)
37	250025024	AID LEG PLUG (W)
38	250024001	SPRING
39	250023000	ADJUSTING FOOT
40	250013007	LEAD SHAFT
41	230140002	TENSION SPRING
42	754036003	SPRING
43	270087004	SELECT DIAL
44	xxxxxxxxx	SELECT DIAL INDICATED PLATE
45	355026001	SET SCREW
46	270644304	UPPER TENSION COMP.
47	260035006	SET SCREW
48	301008000	SET SCREW
49	301008000	SET SCREW
50	230008007	TENSION CHECK SPRING
51	301261003	SET SCREW
52	250006007	NEEDLE PLATE
53	270640104	EXTENSION COVER
54	301185105	SET SCREW
55	353049004	PANEL FIXATION
56	370048006	HINGED SCREW
57	xxxxxxxxx	RATING PLATE
58	270235xxx	FRONT COVER
59	370221005	FACE PLATE FIXING PLATE B

2

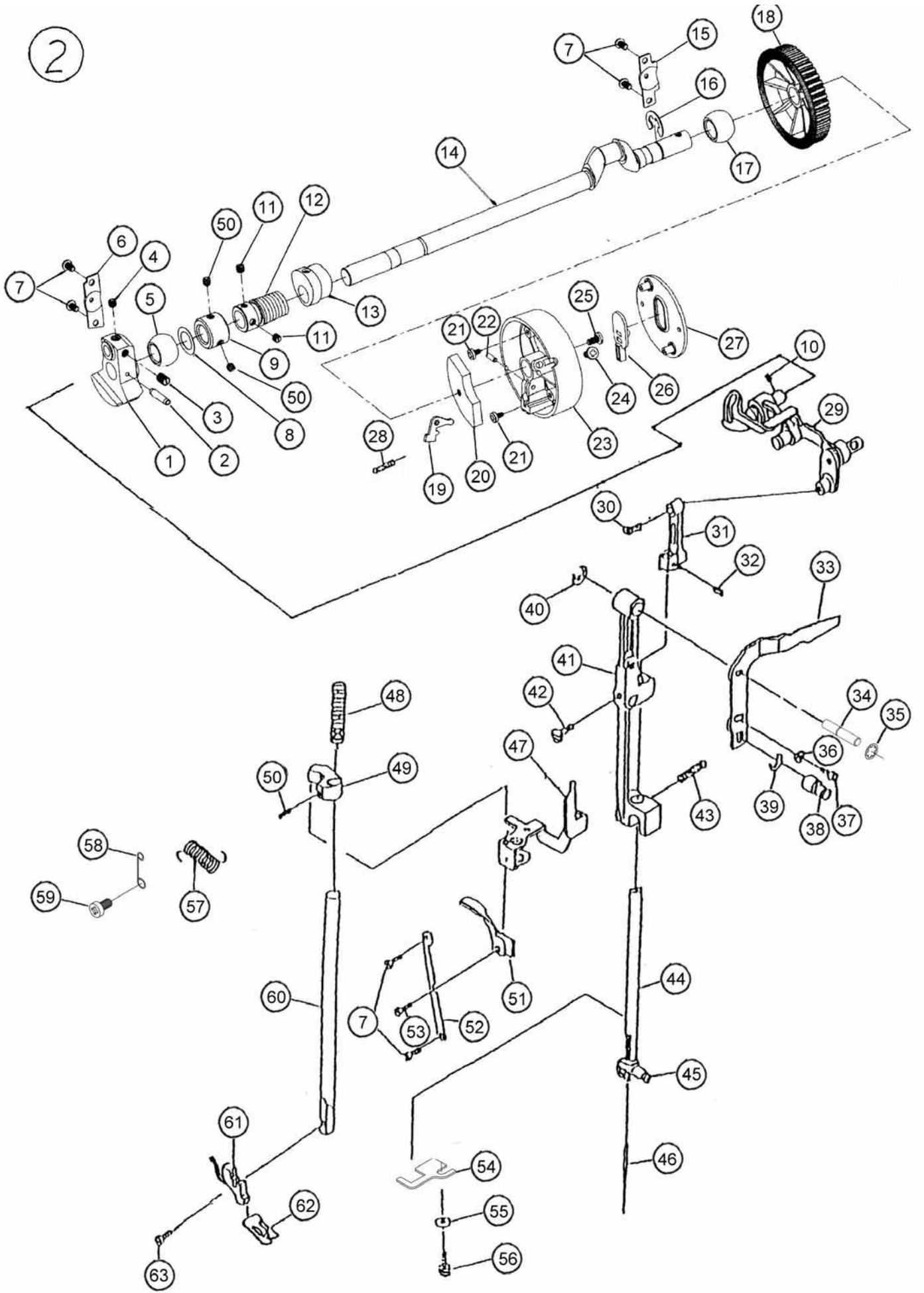

ref no. ---	part no. -----	name of parts -----
01	301083009	THREAD TAKE-UP CRANK
02	000003508	SPRING PIN 4*20
03	301084000	SET SCREW
04	301068008	SET SCREW
05	250002003	FRONT BUSHING
06	250004005	FRONT BUSHING BRACKET
07	301008000	SET SCREW
08	301086002	NYLON WASHER
09	301340306	COLLAR
10	301046000	SET SCREW
11	301093002	UPPER SHAFT SET SCREW
12	370040204	UPPER SHAFT GEAR
13	370504005	SELECT CAM COMP
14	220001009	UPPER SHAFT
15	250005006	REAR BUSHING BRACKET
16	000000907	E RING UPPER SHAFT
17	250002003	FRONT BUSHING
18	220002000	MOTOR BELT
19	220004002	WHEEL TRANSPORT PLATE
20	220008006	BALANCE PLATE
21	000011222	SET SCREW
22	220005003	TRANSPORT PIN
23	220003001	HAND WHEEL
24	000016032	SCREW
25	2500087002	SET SCREW
26	220006004	CLUTCH BUTTON
27	220007005	WHEEL COVER
28	610100000	SPRING
29	301544003	TAKE-UP LEVER CAMP
30	301100003	SET SCREW
31	301503000	NEEDLE HOLDER
32	301046000	SET SCREW
33	370011000	ZIGZAG DRIVING PLATE
34	220028002	SUPPORTER
35	000012326	RING
36	301245001	WASHER
37	301016001	SET SCREW
38	301045009	ECCENTRIC PIN
39	000000206	SNAP RING 4D
40	000000309	SNAP RING 5D
41	250089004	NEEDLE BAR SUPPORTER
42	301016001	SET SCREW
43	301047001	SPRING
44	260042006	NEEDLE BAR
45	260502009	NEEDLE CLAMP COMP
46	301244000	NEEDLE
47	230010002	TENSION RELEASE LEVER *A
48	290026007	SPRING
49	301252001	GUIDE BRACKET
50	301087003	SET SCREW
51	370154006	PRESSER BAR LIFTER
52	250007008	PRESSURE BAR LIFTER
53	301070003	HINGED SCREW 4
54	220030007	NEEDLE BAR STOPPING PLATE
55	301245001	WASHER
56	301049003	SET SCREW
57	370147006	SPRING
58	271094007	TENSION SPRING SETTER
59	301037008	SET SCREW
60	301061001	PRESSER BAR
61	301522005	PRESSER FOOT HOLDER
62	353012008	ZIGZAG PRESSER FOOT
63	610012004	SCREW

3

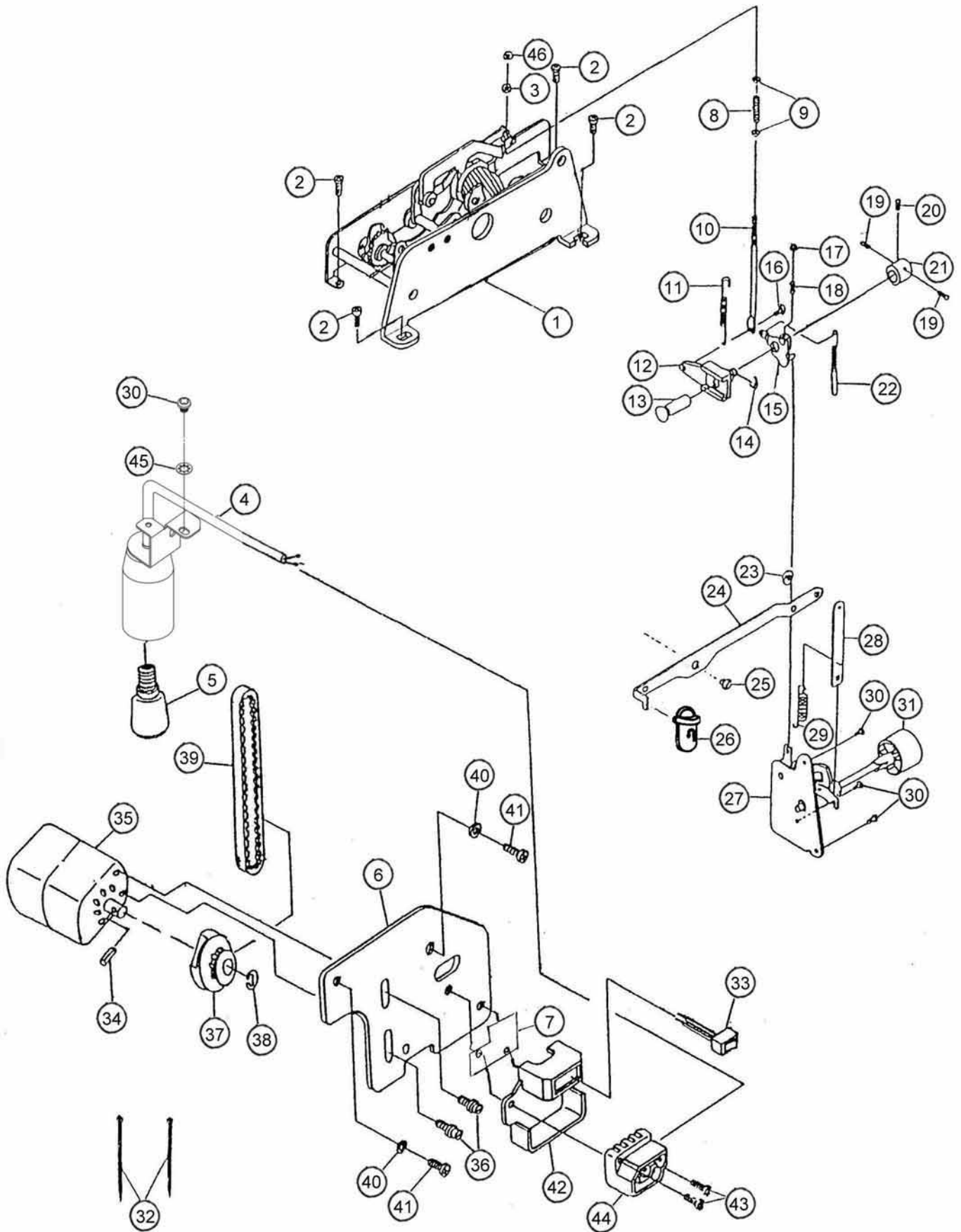

ref no. ---	part no. -----	name of parts -----
01	220605010	PATTERN COMP. (15 PATTERN)
02	301008000	SET SCREW
03	301151009	NUT
04	270826209	LIGHT CORD COMP.
05	650816103	LIGHT BULB
06	260025003	MOTOR BRACKET
07	260050007	INSULATED PLATE
08	370043001	ROD SPRING
09	370044002	WASHER
10	370042000	STRETCH STITCH ROD
11	301155003	SPRING
12	250081006	FEED REGULATOR
13	301152000	FEED REGULATOR SHAFT
14	000000505	SNAP RING 9D
15	270022001	ADJUSTING PLATE
16	301154002	HINGED SCREW
17	301151009	NUT
18	301289007	SET SCREW
19	301046000	SET SCREW
20	301087003	SET SCREW
21	301153104	COLLAR
22	370045003	SPRING
23	270034006	CONNECTING PIN
24	270025004	FEED CONNECTING ROD
25	270014000	HINGED SCREW
26	270308118	REVERSE BUTTON
27	270606108	STITCH LENGTH DIAL COMP
28	270026005	FEED CONNECTING ROD
29	270033005	SPRING
30	301037008	SET SCREW
31	xxxxxxxxx	STITCH DIAL
32	351047006	BAND
33	250831009	SWITCH COMP.
34	000003807	SPRING PIN 2*14
35	230813003	MOTOR COMP.
36	000063023	SET SCREW
37	301555007	MOTOR WHEEL COMP.
38	000000103	SNAP RING 3D
39	301285106	BELT
40	450063008	SPRING WASHER
41	301143008	SET SCREW
42	260026015	SWITCH FIXED PLATE
43	000063001	SCREW
44	000063034	RECEPTACLE
45	301257006	WAVE WASHER

4

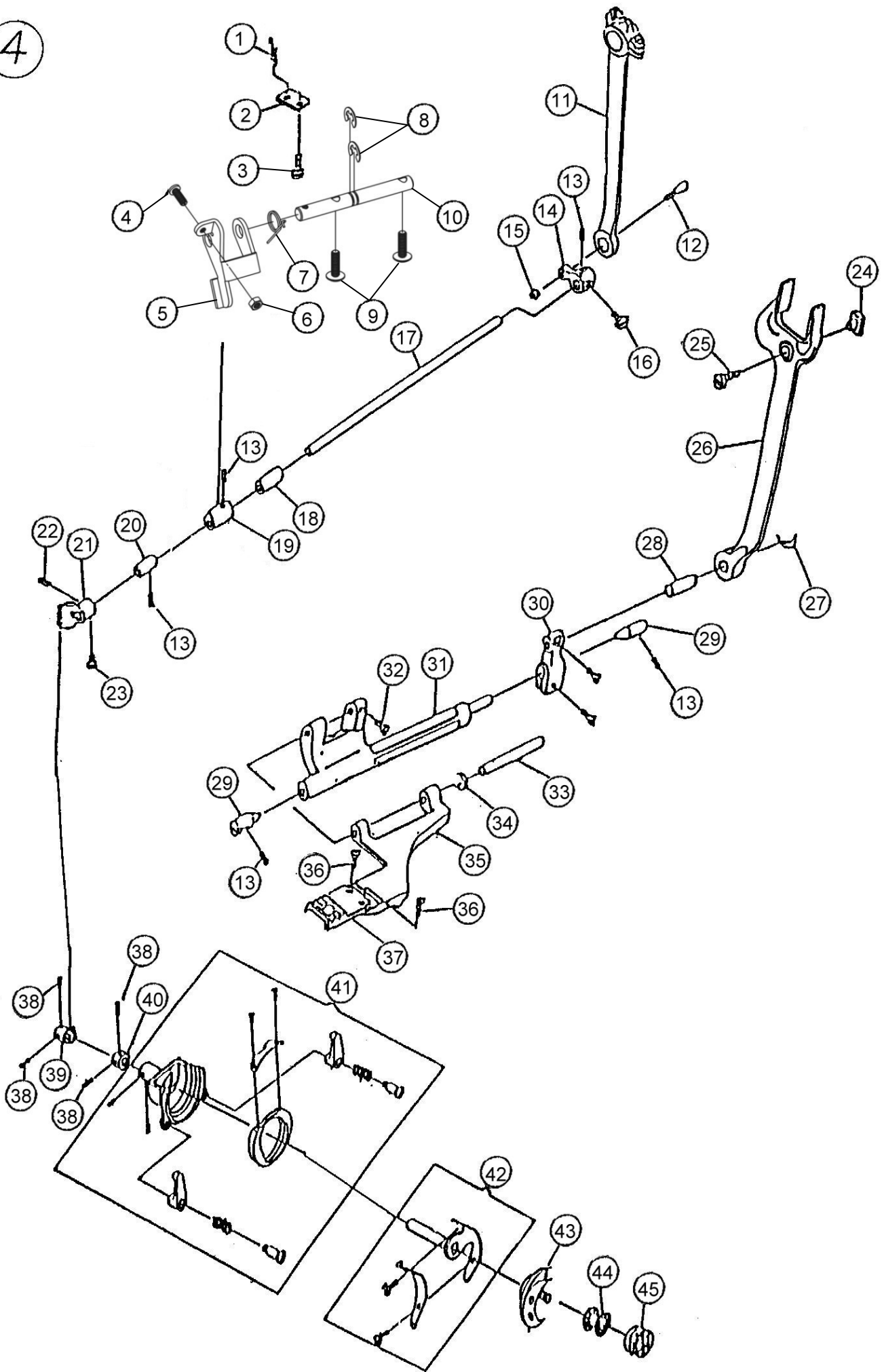



ref no. ---	part no. -----	name of parts -----
01	301181008	FEED DOG BASE SPRING
02	301197007	SPRING HOLDER
03	301185002	SET SCREW
04	220012003	SET SCREW
05	220011002	DROP FEED CRANK
06	301151009	NUT
07	301195005	SPRING
08	000000309	SNAP RING 5D
09	250010004	SET SCREW
10	220010001	UP/DOWN SHAFT
11	301512002	CRANK ROD COMP
12	301106009	TAPER SCREW
13	301087003	SET SCREW
14	353014000	LOWER SHAFT BRACKET
15	301107000	NUT
16	353015001	SCREW
17	301109002	LOWER SHAFT
18	301110006	LOWER SHAFT FRONT BUSHING
19	301182102	FEED LIFTING CAM
20	301111100	LOWER SHAFT REAR BUSHING
21	301113009	OSCILLATING SHAFT GEAR
22	301115001	SET SCREW
23	301114000	SET SCREW
24	301147002	FORKED ROD SLIDE BLOCK
25	301146001	FORKED ROD SLIDE BLOCK DRAFT
26	301145000	FORKED ROD
27	000000402	SNAP RING 6D
28	301179003	CONNECTING PIN
29	301241007	CENTER PIN B
30	353517007	FEED ROCK CRANK
31	301171005	FEED ROCK SHAFT
32	301131003	SET SCREW
33	301173007	FEED DOG BASE SHAFT
34	000000206	SNAP RING 4D
35	301172006	FEED DOG BASE
36	301175009	SET SCREW
37	301174008	FEED DOG
38	301046000	SET SCREW
39	301130105	BEVEL GEAR
40	301129101	COLLAR
41	301542207	HOOK RACE BODY COMP.
42	301541000	HOOK RACE SHAFT COMP.
43	301132406	HOOKPANEL
44	610081004	BOBBIN
45	301515304	BOBBIN CASE

5

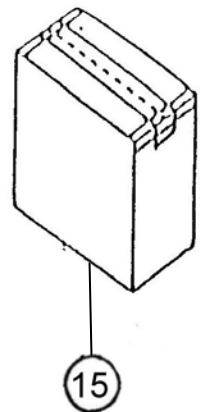
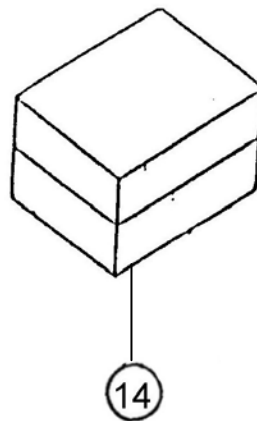
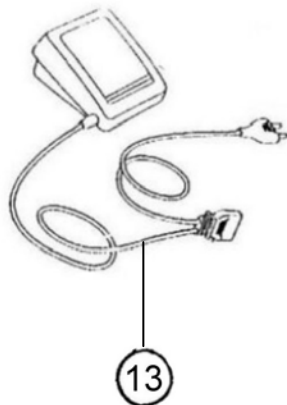
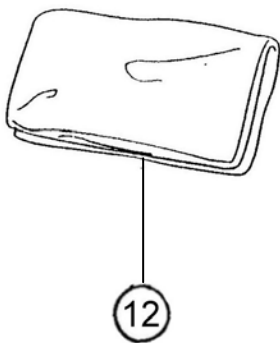
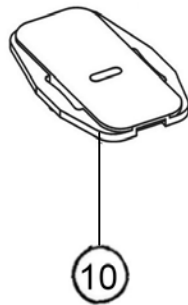
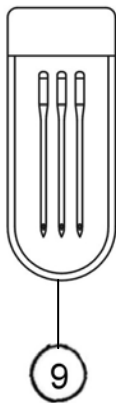
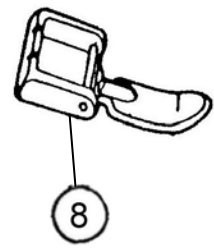
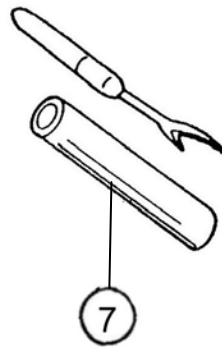
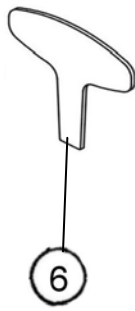
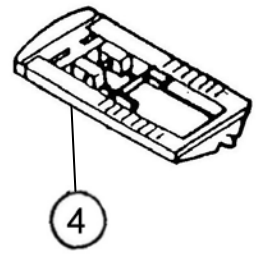
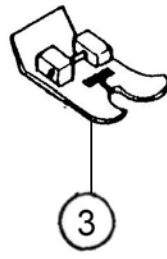

ref no. ---	part no. -----	name of parts -----
01	610081004	BOBBIN
02	301403009	FELT
03	353012008	ZIGZAG PRESSER FOOT
04	303401003	BUTTONHOLE FOOT
05	301439004	SCREW DRIVER
06	660403001	SCREW DRIVER
07	303403201	BUTTONHOLE KNIFE
08	301438003	ZIPPER FOOT
09	270660708	NEEDLE BAG COMP.
10	220401003	FEED COVER PLATE
11	xxxxxxxxxx	INSTRUCTION MANUAL
12	353435805	DUST COVER
13	230814004	CONTROLLER COMP (230V)
14	270310009	POLYFOAM COMP
15	xxxxxxxxxx	CARTON



# HSM-2715

高林股份有限公司 KAULIN MFG. CO., LTD.